

# Sustainable development and energy efficiency



POWER GUIDE 2009 / **BOOK 01**

# INTRO

**Energy efficiency, environment, health, conservation of energy and raw materials, new regulations, Green Buildings, etc., are just some of the topics concerning sustainable development that will have an impact on the day-to-day life of those involved in the electricity sector, at the forefront of which is Power.**

**The purpose of this book is to help readers understand and analyse the numerous voluntary environmental processes, regulations and directives that will have a bearing on any future building project.**

---

This book summarises the global context that foreshadowed and then saw the introduction of new regulatory frameworks for sustainable development, and then goes on describing in detail all the practical provisions for becoming involved in this process at company, installation and building, and product level.

In the context of electrical installations, whether these are residential, commercial or industrial, the main lever for action is referred to as “energy efficiency”. Much of this book is devoted to this subject. Book 2 gives the technical details of this approach using the power analysis process.

In this universal approach which underlies sustainable development, the voluntary part is paramount and each of those involved in the profession must be involved in order to make tangible progress.

## Sustainable development: act now for tomorrow

- 1. Global awareness and increasing numbers of initiatives . . . . . 02
- 2. The building sector has an important role to play . . . . . 02

## Application in companies

- A recognised commitment to sustainable development . . . . . 04
  - 1. The United Nations Global Compact . . . . . 04
  - 2. Extra-financial rating agencies . . . . . 05
  - 3. ISO 14001 certification . . . . . 06
- An established commitment to sustainable development . . . . . 08
  - 1. Environmental projects . . . . . 08
  - 2. Occupational health and safety project: Esculape . . . . . 09

## Application in buildings and installations

- A key area: energy efficiency . . . . . 10
  - 1. Definition . . . . . 10
  - 2. A regulatory and standards-based framework that is intensifying as a result of governmental action . . . . . 10
  - 3. Voluntary processes go beyond regulatory requirements . . . . . 15
- A new way of building: Green Building . . . . . 16
  - 1. Definition . . . . . 16
  - 2. Characteristics of a Green Building . . . . . 16
  - 3. Green Building reference systems and certifications worldwide . . . . . 17

## Application at product level

- A regulatory framework that is intensifying as a result of governmental action . . . . . 18
  - 1. RoHS directive 2002/95/EC . . . . . 18
  - 2. REACH regulation EC/1907/2006 . . . . . 19
  - 3. WEEE directive 2002/96/EC . . . . . 20
  - 4. Batteries and accumulators directive 2006/66/EC . . . . . 20
  - 5. Packaging directive 2004/12/EC . . . . . 21
- Voluntary incorporation of the environment in product development processes . . . . . 22
  - 1. Eco-design of products . . . . . 22
  - 2. Communication of environmental data . . . . . 23

## The energy efficiency process in projects

- 1. The building is the source of improvements . . . . . 24
- 2. Legrand solutions . . . . . 26

## Economical use of energy

- Some concrete examples of progress . . . . . 28
  - 1. Building utilities . . . . . 28
  - 2. Electrical distribution plant . . . . . 32

# Sustainable development: act now for tomorrow

For almost four decades, a number of international summits have been organised to coordinate actions promoting sustainable development at a global level. In the late 1960s, the first criticisms of development models with regard to social and ecological damage appeared.

## 1 GLOBAL AWARENESS AND INCREASING NUMBERS OF INITIATIVES

Mankind is facing one of the greatest challenges in its history: developing in order to “meet the needs of present generations without compromising the ability of future generations to meet their needs” (Our Common Future, Brundtland Report, 1987).

Increasing demands for natural resources, weakening of ecosystems, global warming and soaring population growth are just a few of the global issues confronting us.

Since the end of the 1960s there have been more and more global initiatives to reduce social and ecological imbalances. The movement is now speeding up: those involved are becoming aware of the role they can play within their sphere of influence and of the interdependence between the various aspects of sustainable development.

## 2 THE BUILDING SECTOR HAS AN IMPORTANT ROLE TO PLAY

Our building methods are undergoing massive changes and the main challenge now is to design, build and renovate buildings to reduce their environmental impact and create areas that are healthy and comfortable for the occupants.



### 1972: 1<sup>st</sup> EARTH SUMMIT STOCKHOLM

Foreseeable depletion of natural resources.  
Club of Rome Meadows reports on “The Limits to Growth”.  
Birth of numerous environmental protection agencies such as UNEP

### 1992: 2<sup>nd</sup> EARTH SUMMIT RIO DE JANEIRO

Emergence of the 3 pillars of sustainable development: economic progress, social justice and environmental protection

### 1987: BRUNDTLAND REPORT

Birth of the notion of sustainable development: a development that meets the needs of present without compromising the ability of future generations to meet their own needs

### 1997: KYOTO PROTOCOL

Timetable for the reduction of emissions of greenhouse gases responsible for global warming.  
Objective: 38 countries must reduce their emissions by 52% by 2012 (in relation to the 1990 level)

1990

1995

Throughout their life cycle, buildings consume natural resources, generate waste and emit large amounts of CO<sub>2</sub>, contributing significantly to global warming.

A large proportion of the world's population, particularly in the developed countries, spends 90% of its time indoors (source: OECD). In this context, questions of hygiene standards inside buildings and the comfort of occupants are also central issues in the debate.



**On a global average, buildings are responsible for up to:**

- 40% of the total energy use in society
- 40% of CO<sub>2</sub> emissions
- 30% of natural resources consumed
- 30 to 40% of landfilled waste
- 20% of fresh water resources consumed.

Source: United Nations Environment Programme (UNEP)



## Legrand is committed with you

The Legrand Group is aware of all these sustainable development issues, both at global level and building level.

For many years, the Legrand Group has been committed to a process of continuous improvement to ensure the profitable, long-term and responsible growth of its businesses, combining long-term performance with protection of the environment and enhancement of human capital. This commitment is incorporated in the Group's Charter of Fundamental Principles and is based on four values:

- Ethics of behaviour
- Customer awareness
- Resource enhancement
- Innovation

A key part of the Group's commitment is the incorporation of environmental issues at three levels: management of manufacturing and logistics sites, product design, and marketing functions to avoid wasting energy.

The Legrand Group is keen to become involved, together with all those concerned (installers, panel builders, design offices, architects, investors, distributors, etc.), in a global development process in line with the principles of sustainable development, and to contribute today to the development of tomorrow's sustainable buildings.

**LET'S INVEST TOGETHER  
FOR SUSTAINABLE CONSTRUCTION**

### 2002: 3<sup>rd</sup> EARTH SUMMIT JOHANNESBURG

Review 10 years after Rio, acceleration of environmental damage

### 2009 Dec 09: COPENHAGEN CONFERENCE

Representatives of 170 countries attended this conference to prepare for post-Kyoto and to propose a new protocol to fight global warming

2000

2005

Our common future

### 1999: GLOBAL COMPACT

The Secretary General of the UN invited companies to adopt and apply 10 main principles associated with human rights, labour standards, environmental protection and the fight against corruption

### 2006: STERN REVIEW

Report "On the economics of climate change" by Nicholas Stern, vice president of the World Bank. Each country must now invest 1% of its GDP each year in order to avoid the worst effects of climate change. The price of doing nothing could reach 20% of the GDP



# Application in companies

Corporate Social Responsibility (CSR) is the application of the principles of sustainable development at company level.

The World Business Council for Sustainable Development (WBCSD) defines CSR as “the continuous commitment of companies to ethical practices which contribute to economic development while improving the quality of life of employees and their families as well as the community and society in the broad sense”

## A RECOGNISED COMMITMENT TO SUSTAINABLE DEVELOPMENT

From an external viewpoint, the commitment of companies to a CSR process goes together with regular communication on their progress. Joining global initiatives or responding to requests from specialist rating agencies are proof of openness, transparency and involvement.

### 1 THE UNITED NATIONS GLOBAL COMPACT

The Global Compact, launched at the 1999 World Economic Forum in Davos under the impetus of Kofi Annan, United Nations Secretary General, aims at encouraging responsible values and practices in the global markets to enable all people to benefit from the advantages of globalisation.

The United Nations Secretary General invited company

directors to join this international initiative by signing a letter of commitment. The Global Compact is a code of conduct setting out 10 principles in the areas of human rights, labour, the environment and anti-corruption.

### + Legrand adheres to the Global Compact

Legrand's support for the Global Compact since 2006 reflects its willingness to promote its development model throughout the Group and with its stakeholders, and to implement societal, social and environmental values on a global scale. To date more than 50% of our purchase turnover done with our strategic suppliers is made with those who support the Global Compact too.



## The 10 Principles of the Global Compact



- 1 - Businesses should support and respect the protection of internationally proclaimed human rights
- 2 - Businesses should make sure that they are not complicit in human rights abuses
- 3 - Businesses should uphold the freedom of association and the effective recognition of the right to collective bargaining
- 4 - Businesses should uphold the elimination of all forms of forced or compulsory labour
- 5 - Businesses should uphold the effective abolition of child labour
- 6 - Businesses should uphold the elimination of discrimination in respect of employment and occupation
- 7 - Businesses should support a precautionary approach to environmental challenges
- 8 - Businesses should undertake initiatives to promote greater environmental responsibility
- 9 - Businesses should encourage the development and diffusion of environmentally friendly technologies
- 10 - Businesses should work against corruption in all its forms, including extortion and bribery



< The progress of the Legrand Group's Social and Environmental process is detailed each year in the Reference Document and the Annual Report

## 2 EXTRA-FINANCIAL RATING AGENCIES

Extra-financial rating agencies assess companies' CSR processes according to their own specific methodologies. They often work based on analyses of public documents and data specifically provided by companies.

The assessments are made available to investors or "ethical" indexes, which select companies in particular on the basis of social, environmental, ethical and governance criteria. The Legrand Group regularly responds to this type of request, thus choosing to submit its performance to expert analysis, in a desire for transparency and continuous improvement.



### Legrand shares are included in the FTSE4GOOD index

Created by the global index company FTSE Group, FTSE4Good is an equity index series that is designed to facilitate investment in companies that meet globally recognised corporate responsibility standards. Companies in the FTSE4Good Index Series have met stringent social and environmental criteria, and are positioned to capitalise on the benefits of responsible business practice. Legrand Group has been independently assessed according to the FTSE4Good criteria,

and has satisfied the requirements to become a constituent of the FTSE4Good Index Series.

FTSE is an independent company jointly owned by the Financial Times and the London Stock Exchange.



### What is extra-financial reporting?

In order to communicate their commitments and report on their progress, companies have progressively incorporated social and environmental data in their conventional institutional and financial communications. This type of reporting has gradually become structured and standardised around global reference systems covering economic, environmental, social and societal areas. The recommendations of the Global Reporting Initiative (GRI) are thus becoming more and more widely used in companies.

# Application in companies (continued)

## 3 ISO 14001 CERTIFICATION

The ISO (International Organisation for Standardisation), a network of the national standardisation institutes of 157 countries coordinated by a Central Secretariat in Geneva, Switzerland, has several standards and certification systems to meet the requirements of business and the broader needs of society. One of the most widely used certification systems, standard ISO 14001, is used for setting up an environmental management system (EMS) for an activity (for example: an industrial site, a logistics activity) or a process (for example: product design). An environmental management system that complies with standard ISO 14001 is based on a voluntary process that must enable the following:

- Enhance awareness of the environmental impacts of the activity
- Ensure compliance with regulations and anticipate future developments
- Improve practices within a process of continuous improvement of environmental performance.

ISO 14001 certification is obtained as a result of an audit carried out by an accredited external body. Maintaining certification subsequently is dependent on regular (annual) checking that the system complies with the standard and renewal of the certification (every 3 years) by an independent body.

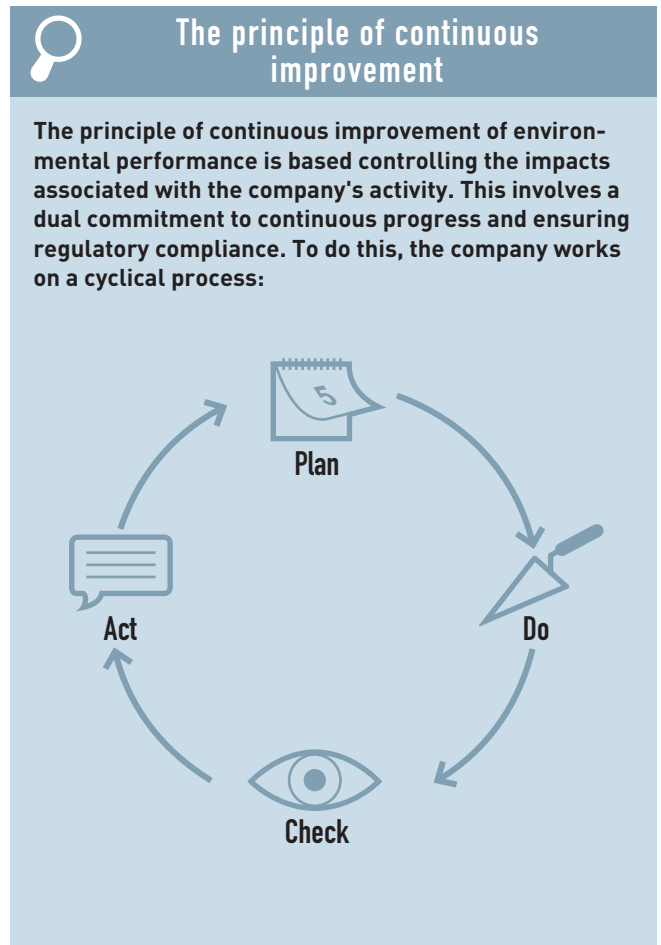

< Legrand has been involved in the reduction of the environmental impacts of its sites for many years, as in the Altis production plant: paint effluent treatment plant





## The Legrand Group and the ISO 14001 standard

■ Proportion (%) of ISO 14001 certified Legrand sites in 2008

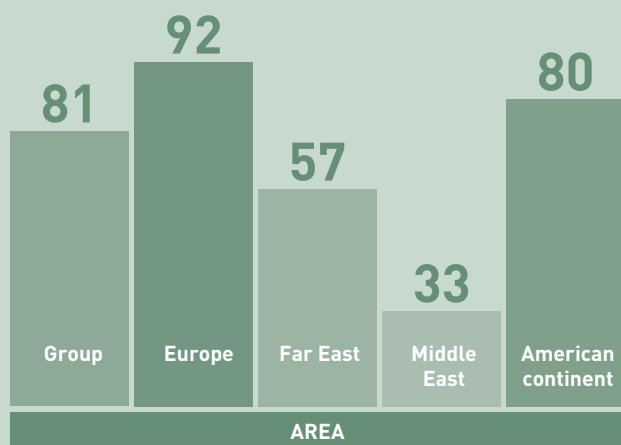

For more than 10 years, the Legrand Group has made significant advances in comparison with the levels required for strict compliance with current regulations. In 2008, 81% of sites worldwide were ISO 14001 certified, an increase of 11% compared with 2007, confirming the high quality of the Group's environmental management. This environmental process includes new acquisitions, as they have to incorporate the Group's environmental strategy within a year of their integration.



Compliance with the ISO 14001 standards is confirmed by a certificate issued by the external inspection body. These official documents are available for you to use, for example to attach to your responses to invitations to tender if required by the project manager.

# Application in companies (continued)

## AN ESTABLISHED COMMITMENT TO SUSTAINABLE DEVELOPMENT

Beyond establishing main principles and defining new values, sustainable development within a company involves setting up cross-disciplinary projects to mobilise people. Companies express their sustainable development personality and identity through these actions.

### 1 ENVIRONMENTAL PROJECTS

#### 1.1. Legrand Climact

The Legrand Climact project was launched in 2007 with the aim of reducing CO<sub>2</sub> emissions across the whole Group. Improved use of natural resources and the development of environmentally-friendly products enable Legrand to position itself as a company that is responsible in this field, with three main principles: controlled energy consumption, eco-design and the transport of goods and people.

#### 1.2. Let's Go Green

In the United States, the "LET'S GO GREEN!" project, developed in 2008, illustrates how sustainable development issues are being taken on board within the Group. For Legrand North America, this strategic priority has led to ISO 14001 certification of four sites and a reduction in electricity consumption of 5.8 million kWh.



**In 2008, 63 % of research units of the Legrand Group was using eco-design principles.**



### Legrand Climact indicators



The Legrand Climact project operates at 3 levels: control of energy consumption, eco-design and the transport of goods and people. Between 2006 and 2008, measured like-for-like and limited to energy consumption at our sites, the project resulted in savings totalling 14,774 tons of CO<sub>2</sub> equivalent, a reduction of 6.4%.

Actions	Savings 2008 <sup>(1)</sup>
Use of rail and sea transport, load optimisation, storage as close as possible to end markets	-1550 (or approx. 2% of the total transport of Group products)
Redesign of certain product ranges	- 5850
New packaging	- 22
Reduction of electricity consumption (excluding heating)	- 7516 (8% reduction <sup>(2)</sup> )
Reduction of energy consumption for heating	- 7258 (5% reduction <sup>(2)</sup> )

(1) Results expressed in metric tons of carbon dioxide equivalent emission (teq CO<sub>2</sub>).

(2) Compared with 2006.

## 2 OCCUPATIONAL HEALTH AND SAFETY PROJECT: ESCULAPE

Launched in 2005, the “Esculape” project is gradually deploying a safety management system, based on the International Labour Organisation’s ILO-OSH 2001 guidelines, throughout the Group.



< The ILO-OSH 2001 guidelines, on which the “Esculape” project is based, determine the main principles for occupational safety and health management systems



The many significant achievements of the “Esculape” project include:

■ **Ensuring compliance with local health and safety regulations**

The “SecuRisk” software, for assessing regulatory compliance, is gradually being implemented in all countries in which the Group has a presence.

■ **Encouraging the incorporation of safety in industrial processes**

The Legrand Group’s purchasing specifications have for example been modified to take Legrand’s sustainable development requirements into account. It includes in particular the principle of not introducing any new substances classified as CMR (Carcinogenic, Mutagenic or toxic to Reproduction) in the manufacturing processes.

■ **Harmonising the preventive health care and safety strategies**

Shared databases are used to consolidate statistical data, with the aim of promoting better preventive health care and safety practices across the Group.



# Application in buildings and installations

The objective is to manage environmental and health-related impacts. Buildings are the principal consumers of energy in the world, accounting for an average of 40% of total energy consumption. Buildings are also major consumers of water and various natural resources due to the building materials used. Constructing buildings in a different way to reduce their environmental impact has become a major issue.

## A KEY AREA: ENERGY EFFICIENCY

### 1 DEFINITION

At building level, energy efficiency covers all the methods used to reduce the energy used for a given service (heating, lighting, operating machines, etc.). Two types of energy efficiency are generally taken into consideration:

- Energy efficiency associated with the framework  
This corresponds to the structural properties of the building that will reduce energy requirements (and in particular heating and lighting). This category includes: optimised insulation, double glazing, treatment of heat bridges, management of openings (doors and windows) and coverings (blinds and shutters).
- Energy efficiency from high-performance equipment and as a result of the management of this equipment. High-performance equipment is that providing the best efficiency.

Equipment management is used to adapt the level and duration of the provision of energy to requirements. It corresponds to the installation of products and systems that will regulate and automate energy consumption in the building in order to avoid unnecessary consumption.

### 2 A REGULATORY AND STANDARDS-BASED FRAMEWORK THAT IS INTENSIFYING AS A RESULT OF GOVERNMENTAL ACTION

Many governments have introduced regulations or standards concerning the energy consumption of buildings. They set minimum energy efficiency levels, mainly for residential and/or commercial buildings.



## Glossary

#### ■ Regulations

These are sets of rules to be followed, which are mandatory in all respects as soon as they are published and cannot be applied in an incomplete or selective way.

#### ■ Directive

In European law, the directive sets a target for Member States to achieve, giving them a free choice how they do so (laws, decrees, orders, etc.). Unlike European regulations, which are imposed directly on the citizens of the Union, the directive is not intended to be applied directly to companies and individuals and requires transposition.

#### ■ Standard

This is not mandatory. It is a set of common rules concerning the characteristics of a product, service, process or entity. A standard becomes mandatory if its contents are included in regulations.



## Examples of energy regulations for buildings and installations

**USA: ASHRAE**  
(American Society of Heating Refrigeration and Air Conditioning Engineers)

**European Union: EPBD**  
(Energy Performance Building Directive)

**Russian Federation: EEB**  
(Energy Efficiency Building) codes and standards

**Japan: Energy Conservation Law**

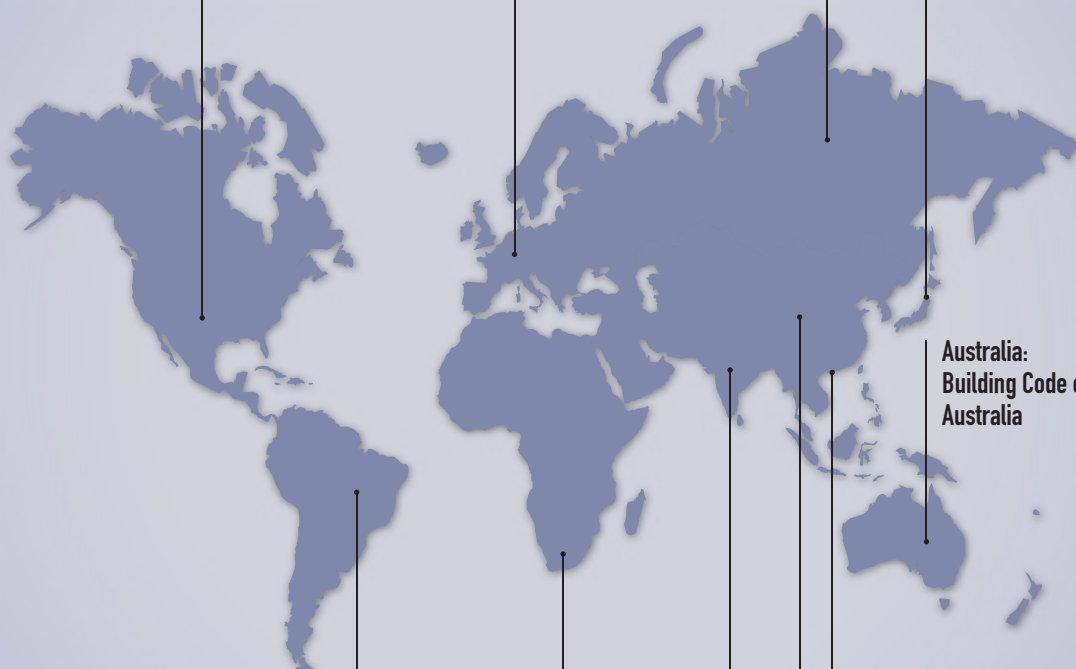

**Australia: Building Code of Australia**

**Hong-Kong: Building (Energy Efficiency) Regulation**

**Brazil: PROCEL EDIFICA**  
(Programa Nacional de Eficiência Energética em Edificações)

**South Africa: SANS 204** (South Africa National Standard 204)

**India: ECBC** (Energy Conservation Building Code)

**China: BEEAR** (Building Energy Efficiency Administration Regulation)

In blue: not currently mandatory



# Application in buildings and installations (continued)

## 2.1. In Europe : Energy Performance Building Directive (EPBD)

The European Union sets up the Energy Performance Directive in 2002, placing the emphasis on reducing energy consumption by means of building standards. This directive sets four objectives for European Union countries:

- Development of an integrated method for calculating the energy performance of buildings: this must take account of all the factors determining the energy efficiency (insulation, heating, cooling and lighting installations, position and orientation of the building)
- Setting minimum energy performance requirements for new buildings and existing buildings that are subject to major renovation work
- Setting up certification systems confirming the energy performance of buildings in order to provide the information to tenants or buyers via energy performance diagnoses (EPD)
- Organisation of regular general inspection of boilers and air conditioning systems. National governments are currently responsible for transposing this directive and its objectives to country-level.

### > Best Practice in France

2008 marked the launch of a bill setting up the "Grenelle de l'Environnement" whose programme goes beyond European requirements and is gradually making the energy performance objectives for buildings tougher between 2012 and 2020. The performance objectives are based on the energy efficiency labelling system already in place in France: "Bâtiment Basse Consommation" (BBC)<sup>(1)</sup>.

## 2.2. A dynamic regulatory and standards-based process on all continents

### > North America

#### United States

ASHRAE 90.1-2004 standard. ASHRAE, the American Society of Heating Refrigeration and Air Conditioning Engineers:

- Defines minimum thermal requirements for buildings in the building codes
- Defines the building and efficiency standards for the building envelope, the heating, ventilation and air conditioning, domestic hot water, electricity and lighting installations.

#### Brazil

Adoption in 1985 of a national programme for energy efficiency in buildings: Programa Nacional de Eficiência Energética em Edificações (PROCEL EDIFICA), an integral part of the overall energy conservation programme entitled PROCEL (Programa Nacional de Conservação de Energia Elétrica).

Main measures:

- Labelling system to inform consumers
- Energy audits and diagnoses
- Encouragement of the use of more energy-efficient equipment and installations in public and residential buildings
- Reduction of losses in the electrical system.

Since 2001, the Brazilian government has been promoting a number of energy efficiency actions, including the Federal Regulation for Voluntary Labelling of Energy Efficiency Levels (based on the European EPD model) in Commercial, Public and Service Buildings.



### Example: Objectives defined by the "Grenelle de l'Environnement" in France

For new buildings, this involves application of "Bâtiment Basse Consommation", BBC<sup>(1)</sup> (representing consumption of less than 50 kWh/m<sup>2</sup> /year of primary energy) to new buildings by the end of 2012 (end of 2010 for commercial and public buildings). The positive energy building (in France, BEPOS) is a structure whose energy consumption (heat, electricity generated by standalone

systems such as wind power, photovoltaics, etc.) is very low. The positive energy building is a target to be achieved by 2020 according the "Grenelle de l'Environnement". The objective for existing buildings is a 38% reduction in energy consumption by 2020.

[1] Low Consumption Building

## > Africa

### South Africa

South Africa has set itself the objective of a 15% reduction in the energy demand of buildings by 2014. By means of the Draft Energy Efficiency Strategy (2004) the country wants to establish minimum energy efficiency levels and a mandatory programme of energy efficiency audits.

For commercial buildings, the energy performance standards are defined in SANS 204 (South Africa National Standard 204) which is to be incorporated in the Building Code (making SANS 204 mandatory).

## > Asia

### Japan

Two standards belonging to the Energy Conservation Law adopted in 1979:

- Criteria for Clients on the Rationalization of Energy Use for Buildings for non-residential buildings
- Design and Construction Guidelines on the Rationalisation of Energy Use for Homes for residential buildings.

### China

In 2006, establishment of the "Building Energy Efficiency Administration Regulation" (BEEAR) by the Chinese government.

Requires:

- Minimum energy efficiency levels to be reached in all new buildings
- That all building and insulation materials, doors, windows, and heating, lighting and air conditioning installations have an inspection certificate, a data sheet and a label certifying that the product complies with the local energy efficiency standards.

Once they have been installed, these products must be tested in situ and the results must be sent to a quality control institute.

From now on, the building code requires energy savings of around 50 to 60% to be achieved in comparison with non-insulated buildings.

### Hong Kong

Regulations on the energy efficiency of buildings since 1995: Building (Energy Efficiency) Regulation. Concerns commercial buildings and hotels.



# Application in buildings and installations (continued)

## India

In India, there are several different codes and regulations applicable to buildings. The National Building Code (NBC), developed by the Bureau of Indian Standards, provides general guidelines on energy use without setting performance/consumption limits. For commercial buildings, the Energy Conservation Building Code (ECBC) lists numerous requirements on building features that influence building energy performance. The ECBC is applicable to buildings or building complexes that have a connected load of 500 kW or more or a contract demand of more than 600 kVA with a minimum area of 1000 m<sup>2</sup>. The energy efficiency building code includes both a prescriptive (sets separate energy efficiency requirements for each building part and for each part of the equipment) and an energy performance method (based on a building's overall consumption of energy). The code will be voluntary at first as it has to be adopted by each of the individual federal states to become mandatory.

## > Oceania

### Australia

In 1999 Australia defined a strategy designed to improve the energy efficiency of its residential and non-residential buildings.

The Australian government established a minimum energy performance level in the Building Code of Australia. In addition, the Australian Government is currently working with State and Territory governments to develop a new nationally consistent mandatory disclosure scheme for commercial office building energy efficiency.



## > Russia

Adoption of the Energy Efficiency Building (EEB) Codes and Standards at country level in 2003 (based on codes already developed at regional level).

Applies to both new and existing buildings.

Objective:

- To classify new and existing buildings according to their energy performance level. Energy passports provide buyers and residents with information on the energy properties of the building
- To create mechanisms for identifying lower performance buildings and ensure they are upgraded
- To develop methods for testing compliance of the project in terms of thermal performance and energy efficiency throughout the life cycle of the building (design, construction, use).





### 3 VOLUNTARY PROCESSES GO BEYOND REGULATORY REQUIREMENTS

Throughout the world, numerous bodies support ambitious voluntary processes that demand very high energy efficiency levels. In addition, with a view to continuous improvement of energy performance levels, certain countries are toughening their regulations and gradually incorporating these programmes or voluntary labels as minimum performance levels. In Europe, various low consumption building certification programmes have been developed in a number of countries. In Switzerland for example, the Minergie label is awarded to houses whose heating and domestic hot water requirements are below 42 kWh/m<sup>2</sup>/year. As a comparison, the average consumption

of a building is in the region of 400 kWh/m<sup>2</sup>/year worldwide. In Germany, the “Passivhaus” (passive house) programme is growing fast.

In the United States, Canada, Australia, New Zealand and Japan, there are increasing numbers of housing projects using the same amount of energy as they produce: these are Zero Energy Homes (ZEH). A zero-energy house must be self-sufficient in terms of its annual energy bill. To do this, it must produce the electricity and part of the energy needed to meet its heating requirements itself. A house can therefore be zero-energy across the annual bill, but does not have to be totally self-sufficient all the time: it will tend to produce a surplus of energy in the summer and consume more than it produces in the winter.

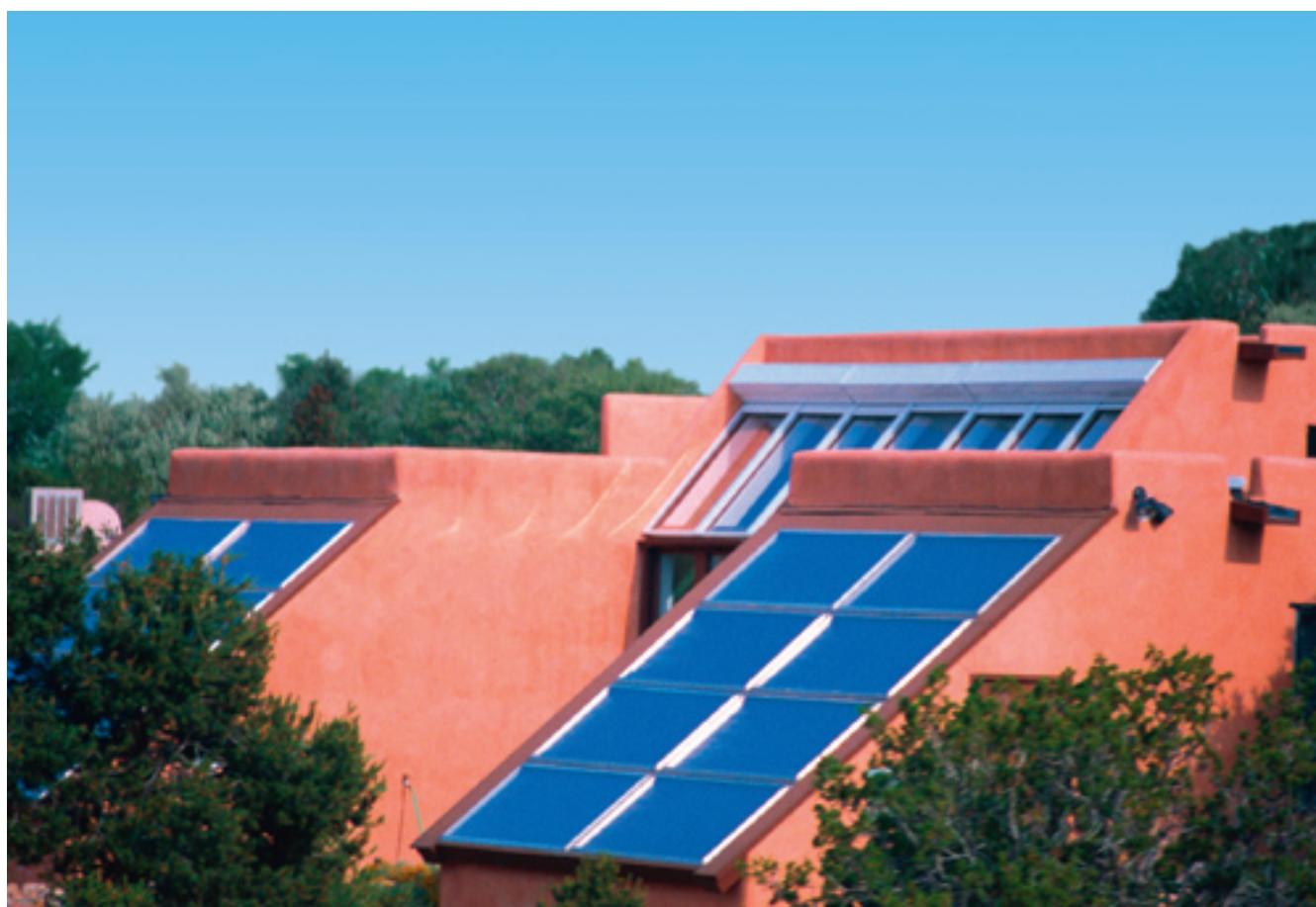

# Application in buildings and installations (continued)

## A NEW WAY OF BUILDING: GREEN BUILDING

### 1 DEFINITION

The Green Building has a wider scope than the energy performance processes. It takes into consideration all the environmental impacts of the building while optimising quality of life for occupants and reducing operational costs (energy and water consumption, maintenance, waste, etc.). In fact a Green Building construction project is approached from the aspect of overall cost: it takes account of not only the initial investment for construction, but also the operation and end of life of the building.

### 2 CHARACTERISTICS OF A GREEN BUILDING

A Green Building project must take numerous parameters into consideration throughout the life cycle of the building:

#### ■ Sustainable sites

Taking account of the immediate environment: assessment of the terrain, the construction site and the direct environment: study of the physical environment (topography, hydrology, natural risks, pollution of the subsoil), local biodiversity, climate, local nuisances, local resources.

#### ■ Internal building quality

- Comfort of the occupants: visual (priority given to natural lighting), olfactory, relative humidity, acoustic
- Hygiene standards of the building: hygiene standards of the areas (quality of materials, combating damp, development of micro-organisms, etc.), avoidance of the risks of air pollution (adhesives, paints) and optimisation of ventilation systems, and water hygiene standards.

#### ■ Waste management

Installations for selective sorting, composting, etc.





### ■ Energy management

Limitation of energy losses, maximisation of the energy efficiency of the building, use of renewable energies.

### ■ Water management

Rainwater collection systems, water-saving installations.

### ■ Materials & resources

Choice of systems and processes that have a low environmental impact, with responsible use of natural building materials and products (for example sustainable forest management) or reused, recycled and non-toxic materials and products.

### ■ Eco-construction

- Bioclimatic architecture: consists of taking the characteristics of the external climate into consideration in the design and construction of the building in order to maintain comfortable temperatures naturally, to control humidity and encourage natural lighting. In particular bioclimatic architecture tries to use available solar energy in the form of light or heat, in order to use as little energy as possible for an equivalent level of comfort.

- Low nuisance site: noise, air and ground pollution, waste, waste water.

## 3 GREEN BUILDING REFERENCE SYSTEMS AND CERTIFICATIONS WORLDWIDE

Green Building practices are being increasingly promoted at country level by the establishment of building assessment and certification systems. There are numerous Green Building rating/certification systems in existence throughout world. The main systems are :

- LEED®: United States, Canada, Brazil, India, Mexico, Dubai
- GREEN STAR®: Australia, South Africa, New Zealand
- BREEAM®: United Kingdom
- HQE®: France
- DGNB®: Germany.



### Characteristics of assessment systems

Most of these assessment systems have a number of common characteristics:

- A system of points allocated according to the performance of the building in various areas and with regard to various criteria (often called credits)
  - Allocation of a grade to the building (for example: gold, silver, etc., or high performance, very high performance, etc.) according to the number of points obtained
  - Prerequisites (mandatory criteria) based on regulations and standards
  - Common subjects: consumption of resources, internal air quality, etc.
  - Suitability of the system for the type of building
- What differentiates systems from one another is generally the organisation of the subjects and the scoring criteria, and the standards on which these criteria are based: the minimum performance levels to be reached will differ according to local regulations.



### Legrand is involved in Green Building processes

The Legrand Group has been supporting Green Building processes in the United States since 2004 and in the United Arab Emirates since 2008 through its membership of the Green Buildings Councils (GBC) of these countries (USGBC and EGBC). National GBC are non-profit organisations committed to expanding sustainable building practices. Generally composed of different organisation from the building industry, National GBC are working to advance structures that are environmentally responsible, profitable, and healthy places to live and work. Through its national GBC memberships, Legrand supports the promotion of Green Buildings and sustainable design.

# Application at product level

The objective is to optimise environmental impact and to find solutions for energy efficiency.

## A REGULATORY FRAMEWORK THAT IS INTENSIFYING AS A RESULT OF GOVERNMENTAL ACTION

Worldwide, an increasing number of regulations concerning the environmental impact of products is setting new production rules for manufacturers. This is the case in the European Union, where new directives and regulations are now imposed on electrical and electronic products. They concern the use of hazardous substances and chemicals, the treatment of electrical and electronic equipment waste, as well as the use of energy and product packaging.

### 1 RoHS (REDUCTION of HAZARDOUS SUBSTANCES) DIRECTIVE 2002/95/EC

The objective of European Directive 2002/95/EC is to limit the use of lead, cadmium, hexavalent chromium, mercury and brominated flame retardants (PBE and PBDE) in certain types of electrical and electronic equipment placed on the European market. The marketing of certain products containing these substances has been banned since its application date, 1 July 2006. The maximum concentration limits for these substances by weight of homogeneous material are: 0.1% for lead, mercury, chromium, PBB and PPBDE, and 0.01% for cadmium.

In reality, a limited number of products is directly concerned by the directive which covers the following 8 categories of equipment:

- Large household appliances
- Small household appliances
- IT and telecommunications equipment
- Consumer equipment
- Lighting equipment (household light fittings and electric bulbs)
- Electrical/electronic tools (excluding large fixed industrial tools)
- Toys
- Automatic dispensers.

This directive indirectly affects suppliers of components or subassemblies.

It is the responsibility of the producer to check that

the supplier provides products that meet the requirements of the directive. Finally, the manufacturer is responsible to the customer for compliance with the requirements throughout the whole supply chain. Some countries have established regulations designed to reduce the hazardous substances identified by the RoHS directive. This is the case in Japan, South Korea, China, certain states in the United States, and Canada. In Thailand, Australia and Taiwan, RoHS regulations are currently being developed.

=> These regulations will impact local and electronic products manufacturers who export to those countries.



### Legrand products comply with RoHS requirements

This directive concerns Legrand products and systems very little. All Legrand products that fall within the scope of the RoHS directive have been compliant since 1 July 2006. Moreover, to meet customers' requirements, Legrand has gone beyond its regulatory obligations and has decided to replace substances covered by the RoHS directive in its products.

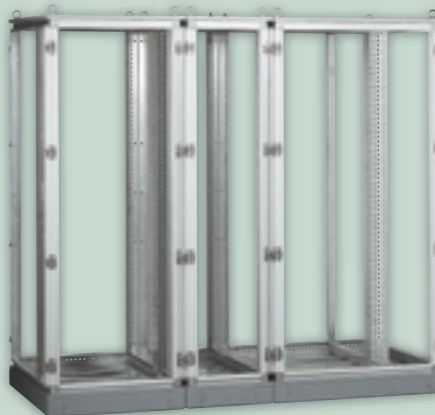

XL<sup>3</sup> metal enclosure with metal uprights

## 2 REACH (REGISTRATION, EVALUATION AND AUTHORISATION OF CHEMICALS) REGULATION EC/1907/2006

In Europe, the purpose of the REACH regulation EC/1907/2006, which came into force on 1 June 2007, is to give the public better protection against chemicals that are available on the market and to make good the lack of knowledge about these chemicals. Initially this regulation made manufacturers and importers of chemicals responsible for providing information on the safety of these substances for health and the environment and the uses made of them: this is the registration phase, which is the basis

of the REACH system. At the same time the function of the REACH regulation is to set up a framework for controlling the risks associated with the use of dangerous substances. Certain substances may therefore be subject to usage restrictions or may even be prohibited. Manufacturers and importers of chemicals must obtain authorisation to use substances classified in the "substance of very high concern" category. A substance could be classified in this category if there is a risk for human health and/or the environment. The aim of this Authorisation is to assure that the risks from substances of very high concern are properly controlled and that these substances are progressively replaced by suitable alternative substances.

### + Legrand complies with the REACH requirements

The Legrand Group has of course taken on board the implications of REACH and is implementing the necessary steps to comply with them.

As a downstream user, Legrand works alongside with its suppliers to ensure to use substances and preparations which have been pre-registered and will be registered within the specified deadlines under REACH.

As a producer of articles, Legrand fulfil the legal obligation to communicate information on the substances included in the Candidate List of Substances of Very High Concern (SVHC) which are present in our articles (article 33.1 REACH).

Beyond this duty of transparency, as part of its active and forward-thinking policy, the Legrand Group is committed as follows :

■ **For existing products:**

As new substances are included in the Candidate List of SVHC, Legrand examines systematically the possibility to substitute the raw materials and articles in which these substances are present and do this each time a technical solution for substitution exists.

■ **For new products:**

The use of raw materials and articles in which substances included in the Candidate List of SVHC are present is banned each time a technical solution for substitution exists.



< For more information on our mutual contribution to a responsible use of chemicals: [www.legrandgroup.com](http://www.legrandgroup.com)



< Role and commitment of Legrand as a producer of articles

# Application at product level (continued)

## 3 WEEE (WASTE ELECTRICAL AND ELECTRONIC EQUIPMENT) DIRECTIVE 2002/96/EC

The main purpose of the WEEE directive is the prevention of Waste Electrical and Electronic Equipment (WEEE) and its re-use, recycling and any other form of recovery so as to reduce the amount of waste for disposal. This directive applies to products sold in the European Union after 13/08/2005.

The WEEE directive concerns electrical and electronic equipment with an operating voltage of less than 1000 V and which is included in the following 10 equipment categories listed below:

- Large household appliances
- Small household appliances
- IT and telecommunications equipment
- Consumer equipment
- Lighting equipment
- Electrical and electronic tools
- Toys
- Medical equipment
- Control and monitoring equipment
- Automatic dispensers

Some other countries have implemented or proposed regulations aimed at reducing electrical and electronic product waste. These include Canada (Alberta), Japan, South Korea, China, Switzerland and Taiwan.



### Legrand complies with the WEEE requirements

For more than 20 years, the Legrand Group has been involved in collecting and recycling end of life equipment. For example, in each European Union country, Legrand implements solutions that comply with the WEEE directive and customers' expectations, and is a member of eco-organisations which manage the collection and treatment of waste.

## 4 BATTERIES AND ACCUMULATORS DIRECTIVE 2006/66/EC

European directive 2006/66/EC dated 6 September 2006 concerning batteries and accumulators and waste batteries and accumulators, and repealing directive 91/157/EEC, prohibits the marketing of most batteries and accumulators containing mercury or cadmium, and establishes rules for the collection, recycling, treatment and disposal of batteries and accumulators. The directive prohibits:

- Batteries and accumulators, whether or not they are incorporated in devices, that contain more than 0.0005% of mercury by weight
- Portable batteries and accumulators, including those incorporated in devices, that contain more than 0.002% of cadmium by weight.

This directive does not cover "button" type batteries or those made up of "button" type elements. In each European Union country, the producers of portable batteries and accumulators must set up and finance collection and disposal systems for used batteries and accumulators. A company is considered to be a producer of batteries and accumulators when they are imported or brought into the EU.



### Legrand products comply with the Batteries and Accumulators Directive

Legrand ensures not only that the batteries and accumulators incorporated in its products comply with these regulations, but also that they are disposed of in an appropriate way. The user is informed of the presence of batteries and accumulators in the products. They are clearly marked so that they can be disposed of correctly (separate collection, recycling, heavy metal content).

## 5 PACKAGING DIRECTIVE 2004/12/EC

European directive 2004/12/EC (amending directive 94/62/EC) concerning packaging and packaging waste highlights the priority to be given to the prevention of waste. This directive applies to “all packaging placed on the market in the Community and all packaging waste, irrespective of its composition, whether it is used or discarded by industries, businesses, offices, workshops, services, households, or at any level”.

This directive establishes precise targets for Member States for recovery and recycling of packaging. The targets for 31 December 2008 are:

- Recovery of at least 60% by weight of packaging waste
- Recycling of 55 to 80% by weight of all materials contained in packaging waste.

One-piece cardboard XL<sup>3</sup> packaging can be re-used for the delivery of the assembled enclosure to the site >



### Legrand products comply with the Directive on packaging

In line with its customers' expectations (quality, price), Legrand has reduced the volume and size of its packaging, for:

- Easier recycling of waste
- Management of the impacts connected with transport (repercussions of weights and volumes on logistics). To this end, Legrand favours the use of single material packaging (cardboard) rather than packaging made of several plastics for example, thus making them easier to recycle.





# Application at product level (continued)

## VOLUNTARY INCORPORATION OF THE ENVIRONMENT IN PRODUCT DEVELOPMENT PROCESSES

### 1 ECO-DESIGN OF PRODUCTS

Eco-design is a process that consists of taking environmental aspects into account when designing or improving a product. This concept is based on the following principle: all products have environmental impacts at various stages in their life cycle. The purpose of eco-design is to reduce these impacts while maintaining the user quality of the product.

The eco-design of a product involves incorporating environmental aspects in the product development process. This involves various stages:

- Manufacture with materials, components and production processes
- Distribution with packaging and logistics
- Use with energy consumption, servicing and maintenance
- End of life.

### + A voluntary eco-design approach at Legrand Group level

Since 2001, the Group has been committed to better incorporation of environmental issues in the development of its products. Implemented initially from France, the Legrand Group's eco-design process will be applied in all design offices by 2010.

The Legrand Group's eco-design process is based on two international standards:

- Standard ISO 14062 provides a framework for the environmental management of products and for incorporating environmental aspects in the design and development processes for these products.
- The ISO 14040 series of standards concerns Life Cycle Assessment (LCA).

#### ■ Altis

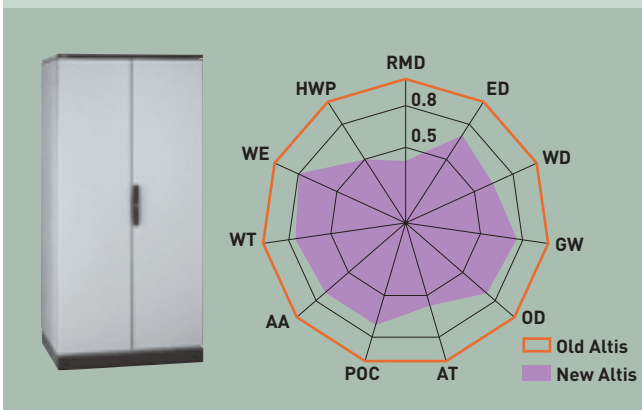

The number of parts and different materials in the Altis enclosure has been reduced by 20%, as has its energy consumption. Its impact on the depletion of natural resources has decreased by 57%. For 10,000 units a year:

- Materials savings: 90 t of zinc and 350 t of steel
- Reduction in carbon emissions: 2000 teq CO<sub>2</sub>.

The 11 environmental impact indicators defined by the EIME software tool:

- RMD (Raw Material Depletion): Depletion of unrenewable natural resources, expressed as a fraction of the global reserve (minerals, fossils, etc) which disappears each year according to the current level of consumption.
- ED (Energy Depletion): Total energy consumed by the product throughout its life cycle.
- WD (Water Depletion): Total water consumption.
- GW (Global Warming): Contribution to the greenhouse effect: gram-equivalent CO<sub>2</sub> release.
- OD (Ozone Depletion): Contribution to the destruction of the ozone layer: gram-equivalent CFC-11 release.
- AT (Air Toxicity): Toxicity emissions in the air
- POC (Photochemical Ozone Creation): gram-equivalent C<sub>2</sub>H<sub>4</sub> release.
- AA (Air Acidification): Air acidification potential: gram-equivalent release of H<sup>+</sup> ion into the atmosphere.
- WT (Water Toxicity): Toxicity emissions in water
- WE (Water Eutrophication): Water Eutrophication (enrichment in nutritive elements)
- HWP (Hazardous Waste Production): Production of hazardous waste.



## ISO 14040 and environmental impact indicators

The ISO 14040 series of standards defines a method for measuring the environmental impact of products. These standards define the principles and context for an LCA, together with the objectives, scope and methods for assessing and interpreting the environmental impact. With the aim of developing eco-designed products, the Legrand Group has installed the Environmental Information and Management Explorer (EIME) software tool for carrying out simplified LCAs. This tool is used in processes for eco-design and information on the environmental impact of its products in the form of Product Environmental Profile (PEP) sheets.

For a Legrand product to be qualified as eco-designed,

its environmental impact must be improved in comparison with the previous generation on at least one of the impact indicators (11 indicators) such as energy consumption or reduction of materials, for the same service provided, without transferring pollution to another indicator.

The new range of industrial plugs and sockets P17 Temptra, designed in accordance with this process, achieves significant improvements in environmental impact in comparison with the previous range:

- 12% reduction in the use of natural resources
- 60% reduction in energy consumption and
- 45% reduction in greenhouse gas emissions.

## 2 COMMUNICATION OF ENVIRONMENTAL DATA

In order to make people aware of their work in the field of eco-design, manufacturers provide information on the properties and environmental profiles of their products. Some companies may provide information on all or some of the environmental characteristics of the product by means of declarations in line with a standards-based framework.

To manage the use of environmental declarations, the ISO has published the 14020 series of standards. The most comprehensive declaration is standard ISO 14025 "Environmental labels and declarations - Type III environmental declarations". This standard gives detailed information on the product for the whole of its life cycle. This type of information is intended for a more technical audience.

### + Product Environmental Profiles (PEP)

The Legrand Group draws up PEPs to provide its customers with environmental information. This eco-declaration describes the following for a product or product category:

- The environmental characteristics (materials, manufacture, distribution, use, end of life)
- The environmental impact throughout its life cycle. It assists selection in the context of a Green Building process.

Meeting the selection criteria of many "Green Building" processes (for example the Commercial Buildings NF standard and the HQE® process in France, or LEED certification in numerous countries, etc.) these PEPs reinforce the benefits of Legrand products on the global market. In 2008, PEPs covered 20% of Legrand brand sales in France. The target for 2010 is to reach 50% of sales in France, Italy and the United States.



< Example of PEP for an XL<sup>3</sup> cabinet

# The energy efficiency process in projects

**The implementation of energy efficiency projects is based on various areas, two of which make up the basic foundation, products and buildings. Some aspects, covered in the preceding pages, are mandatory, while others are voluntary in order to give those involved the freedom or the time to find the best solutions.**

According to different points of view, the process for products will consist of using products that consume less during their whole service life. In time, new regulations will lead to products with the poorest energy efficiency being excluded from the market. A large number of processes are already under way in lighting and electronics, and numerous manufacturers, like Legrand, are working to make their products consume less and cause less pollution.

The other essential area is that of the buildings and installations that contain these products. Because, having "good products" is of no use if they are not used in accordance with precise rules, identified requirements and with a performance objective, in this case energy efficiency. Just as the fact of making cars safer has not on its own made the roads safer. It is the development of infrastructures, the rules of the highway code and regulatory pressures that have brought about this improvement.

## **1 THE BUILDING IS THE SOURCE OF IMPROVEMENTS**

Because they consume a huge amount of energy, buildings themselves represent, on their own, the source, the target and the medium for the energy efficiency process. But they are also places where people live, and as such they incorporate many other ecological aspects in the human and societal sense of the term. The new solutions that will emerge and be implemented must also benefit comfort, health and ease of use - in a word, benefit the individual. Our 21<sup>st</sup> century society must take better care of certain categories: the elderly, the handicapped for whom the ability to

continue living in their own home could be encouraged by accessibility provisions together with the assistance that home automation can provide. Although other energies are used, the mainspring of energy for buildings is electricity. This energy must be managed and saved at source (renewable energies, maintaining the quality level, safety of supply, etc.) and when it is used (consumption, regulation, automation, etc.).

Over the last few years, electrical installations have changed considerably, firstly in terms of ease of use (increasing numbers of circuits, usage points, power sockets), then in terms of safeguarding the supply (discrimination of protection devices, double tap-off distribution, replacement and standby sources) at the same time as in terms of safety (residual current devices, voltage surge protectors, etc.).

An important new area, based around energy quality (derating due to harmonics, RMS measurements, oversizing the neutral, electrical compatibility, etc.), is already being taken into consideration. (See Book 2 for further information on power analysis).

In addition to the quality of electrical energy, which must of course be maintained (and we must all be aware of this, even as small consumers), the new challenge we must concentrate on now and in the future is the reduction of energy consumption. A reduction that is achieved by means of targeted practical solutions (a few of which are given in the example below) and also via agreements between partners (energy efficiency contracts). All these processes will be more or less indicated or made compulsory by measures to encourage their implementation, like the various successive thermal regulations.





## Standard EN 15232

Totally in line with the European Directive on the Energy Efficiency of Buildings, known as EPBD (see page 12), standard EN 15232 also defines and lists the automation and building management system (BMS) functions that have an impact on energy efficiency and specifies their performance levels and impacts on standard building types.

Relationships between energy systems (incoming energy) and requirements are used to calculate an efficiency factor of the BMS. Values to be achieved are specified for different usage profiles (offices, hotels, restaurants, sales areas, etc.).

As a general rule, in premises that are permanently occupied and have a permanent energy requirement (for example hospitals) the efficiency of the BMS is limited. However, for premises with an intermittent energy profile (hotels, restaurants, industrial buildings, etc.) building management will lead to significant savings. Potential savings as a result of installing a building management system are categorised into four classes: from A (high energy performance) to D (low energy performance). Class C being defined as the “normal” class. In addition to these calculation aspects, this standard gives meaningful usage profiles which demonstrate the usefulness of working them out systematically.

Usage profile for:

■ an office

■ a hotel

■ a hospital

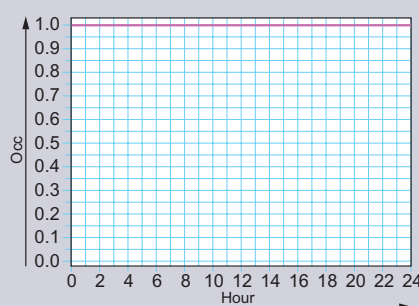
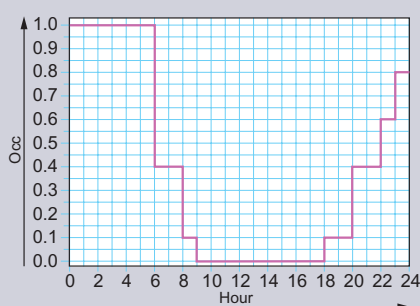
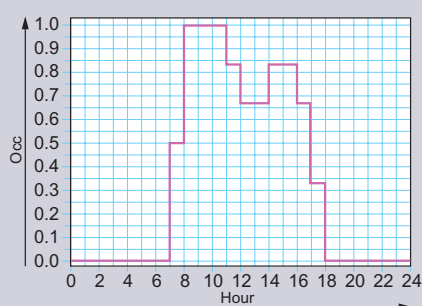

## The energy performance contract

The success of a project is based on the involvement of everyone (project manager, energy operators, owner, manager or user, etc.) and on a rigorous methodology. Defined by European directive 2006/32/EC, this type of contract commits the partners for the contract period to a contractually agreed level of energy improvement. As in France, where professional organisations are committed to promoting the “Contrat de performance énergétique” (CPE), this type of process is used to define all the coordinated actions implemented to improve energy efficiency. Public buildings constitute a priority area for implementing this ambitious initiative which should result in a significant reduction in their consumption over time. It must be possible to check the savings made by means of measurement, or other methods if measurement is not possible or too complex. In the private sector, certain types of business such as hotels or bakeries have started this type of process to improve energy performance specific to the particular features of their own businesses.

# The energy efficiency process in projects (continued)

## 2 LEGRAND SOLUTIONS

Energy efficiency in electrical installations is like a trefoil. First leaf is secure distributed energy, which is how to maintain a constant offer of energy. To make sure devices can work in all types of buildings. Second leaf is energy quality, which is to be sure to get a high level of quality or clean power, in order to make sure that it will not increase the energy bill. Third leaf is energy management (measuring, monitoring and control), in order to use less electricity to reduce bill and consumption.

### 2.1 Secure distributed energy

The objectives of securing energy distributed from an electrical supply network or from a safety power supply device (inverter) must be filled in three ways: safety plant and security facilities, safety devices and safety operation.

### > The safety plant

Designed to protect the facilities and humans against the risk of failure or electric shock. It is the historical or conventional protection.

Legrand has developed many products since the beginning to meet this basic need by providing constant improvements, by changing official documents and creating new products (MCB, MCCB, RCCB).

### > Protection devices

The devices have more and more advanced and intelligent functions (computers, automation and even household appliances) but they have also become more vulnerable to disruption or damage by lightning. The range of protection Legrand can precisely target the particular needs new products to additional arcing power lines and communication.

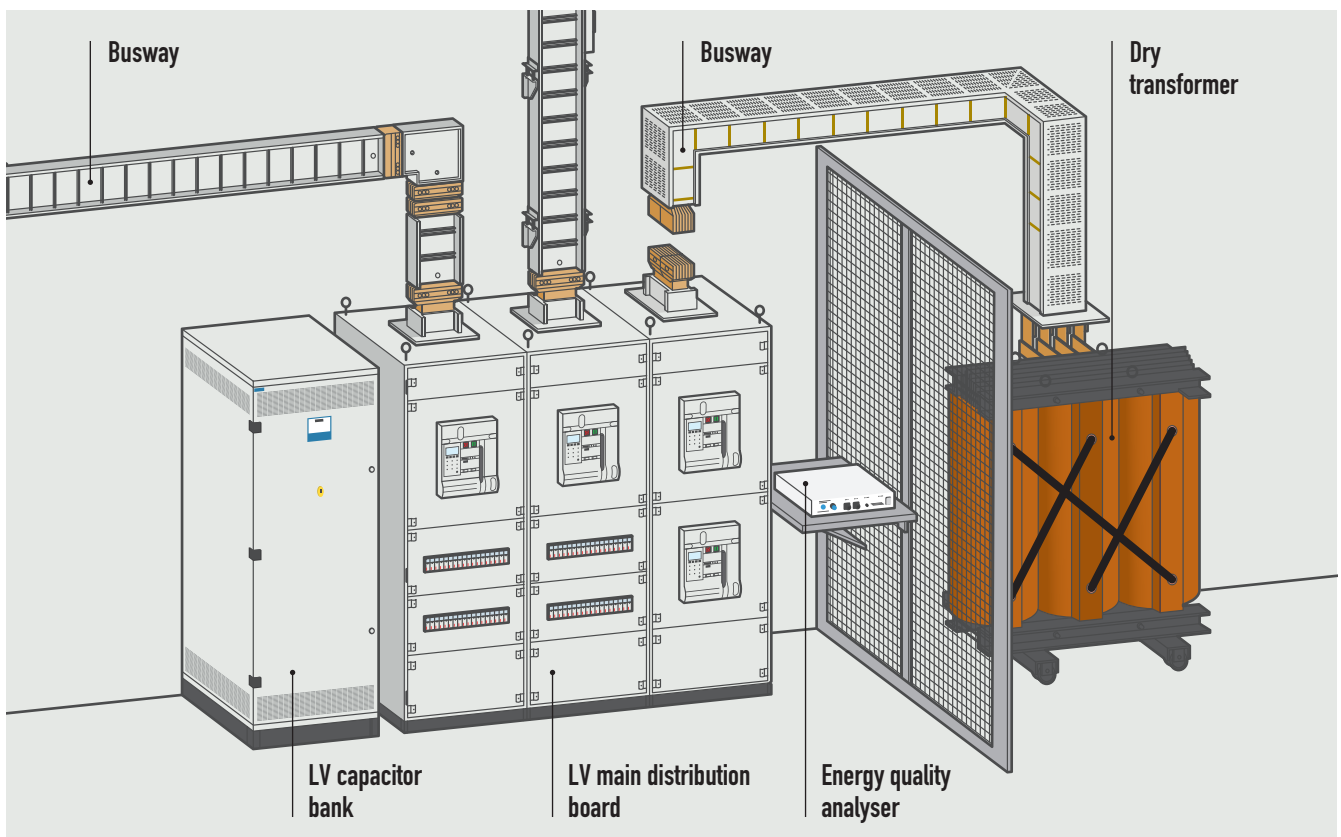



### > Safe Operation

Many processes are essential to the smooth running of businesses and services (eg :air traffic control, traffic lights ...) or health (eg :preservation of the refrigeration procedure), they should not be interrupted. The function of selectivity of the protections given to the highest degree of perfection by Legrand (Logic selectivity, electronic circuit breakers) are used to protect circuits independently. The defects are confined to the circuit in question and the installation can continue to function.

## 2.2 Energy quality

For Legrand, the best way to ensure a good Energy Quality, is to be able to propose the most complete solution as possible, from products to services:

- Cast resin transformers which are offering high environmental quality and high insulation
- Busbars for transport and distribution of high Power: safe, flexible, fast installation system and designed for minimized electromagnetic emissions
- Panels up to 4000 Amps
- Distribution busbars inside the building either for offices, production or even big residential buildings. Even inside the enclosure, we have completed our system with solutions such as:
- High quality ducting to ensure proper EMC (Electromagnetic compatibility)



^ DMX<sup>3</sup> supply inverter in XL<sup>3</sup> enclosure

- Transformers for building and automation with minimal voltage drop and losses
- High quality terminal blocks and marking to ensure proper and long aging connections.

## 2.3 Energy Management

Legrand has developed an open system of Power supervision for its breakers. By doing so our supervision can report to any system, insure proper information, prevent defaults and make maintenance easier. Legrand offers also a full range of metering devices.

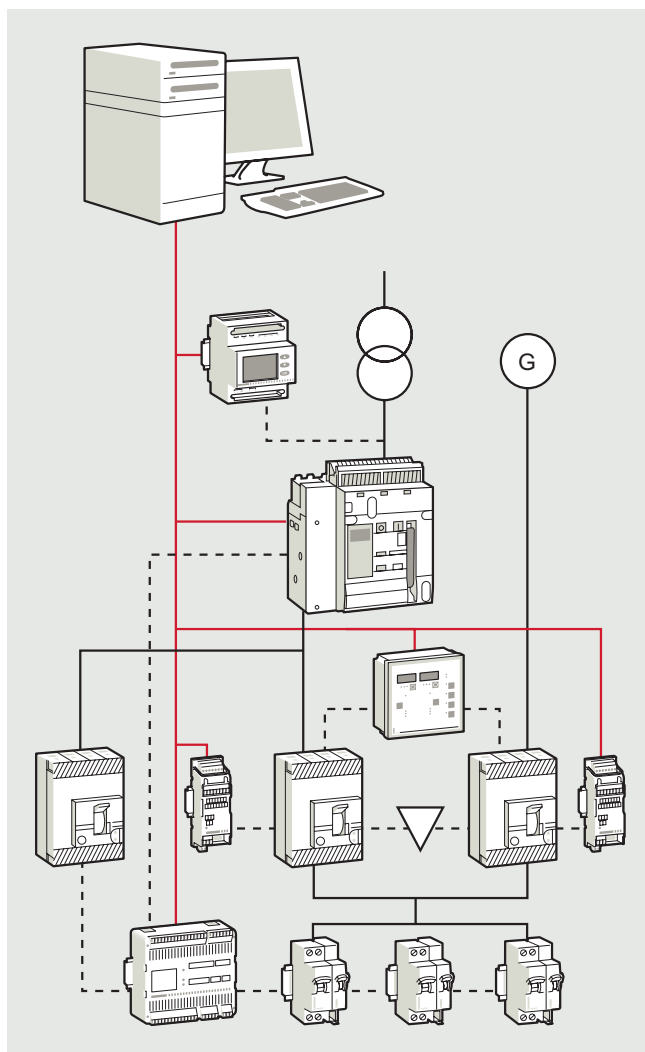

# Economical use of energy

**No-one can deny the fact that there is an urgent need to save energy. We all know there are numerous potential sources of savings. And yet, when we have to translate these precepts into concrete solutions, opinion is divided, there are still no assessment methods and the actual economic savings are difficult to evaluate.**

## SOME CONCRETE EXAMPLES OF PROGRESS

Any building project claiming to come under the heading of sustainable development involves being based on main principles of eco-construction, eco-management, comfort and health, all of which are then defined in the form of more precise, more concrete targets (see page 16 Characteristics of a green building). It must also be possible to translate these targets into existing hardware solutions that provide high technical performance and are applicable and can be assessed in terms of environmental and economic savings. Only these "mature" solutions can then be specified in the usual reference documents: general specifications, special technical specifications. In summary, if only the major principles are specified there is a very strong likelihood of their remaining just "wishful thinking" if they cannot be translated into practical tried and tested solutions.

In each of the areas of progress connected with building projects (management of water, waste, site nuisance, building products, etc.) numerous actions have already been identified and undertaken. In the field of energy management, areas for development have been mentioned, such as the increased use of renewable energies or even the use of lower consumption receivers in particular in industry. High efficiency motors or variable speed control enabling the power to be adapted to just the right level for the load are frequently mentioned. All the industrial tools (furnaces, treatments, electrolysis, welding, etc.) that provide permanent progress in terms of consumption could also be added.

Between this aspect of the source of the energy (on which a great deal of time could be spent, as well as discussion on the use of natural resources, carbon balance, stability or safety of supply) and that of consumption that cannot be reduced below a certain level without damaging general, economic and industrial activity, there is an often large part of energy consumption that is not directly connected (or only

minimally) with productivity which can constitute the source of substantial savings. It is with this in mind that we must consider the energy aspects connected with the electrical distribution infrastructure (transformers, power buses, wiring, power factor management, filtering of harmonics, measurement, etc.) and those associated with the use of energy for the functions of the building itself: the utilities (heating, lighting, ventilation, etc.). Legrand has concentrated on these two areas with the development of innovative and economical solutions.

### 1 BUILDING UTILITIES

#### 1.1. Heating, ventilation and air conditioning (HVAC)



^ Energy recovery in the industrial environment, here on injection presses at a Legrand site

Heating or air conditioning are often the most expensive items on the energy bills of residential and commercial buildings, and represent a significant item for industrial installations. The installation of a regulation system, while ensuring optimum comfort for occupants, optimises the use of energy according to the internal and external conditions and the times during which the areas are occupied.



**A number of standards govern the main regulation of heating and cooling functions (EN 15316) with separate parts for regulation (EN 15316-2-X), for automatic control (EN 15243) and for the order of priority of generators (EN 15316-4-X). Numerous documents are constantly being devised and published in this field and it is an essential prerequisite to consult them. The same applies to ventilation and air conditioning (EN 15241) where the function is divided into regulation of the air temperature, the flow rate (EN 15242, EN 13779) and the cooling effect (EN ISO 13790).**



Programmable time switches



Mosaic room thermostat

## 1.2. Lighting

With approximately 15% of the consumption of electrical energy, lighting constitutes a large part of the consumption of commercial buildings and in particular some of them, such as shopping centres, for which their activity requires a high level of lighting. But light is also a source of comfort, well-being and safety. Great care and real expertise is therefore required in order to make savings on this item. The current trend is to use high efficiency lamps, and electronic ballasts rather than magnetic ballasts. Manufacturers are concentrating on trying to reduce the problems of interference when switching on, and to limit harmonic currents in particular for compact fluorescent bulbs.

**Natural and artificial lighting working together (Legrand Group workshop). Variation (sequential lighting of rows of fluorescent tubes) enables the lighting level to be adapted to the external light level >**



# Economical use of energy (continued)

The different types of lighting (for information only)						
Technology	Power (W)	Efficiency (lumen /watt)	Service life (hours)	Applications	Advantages	Disadvantages
Standard incandescent	0.5 to 1000	10 to 15	1000 to 2000	Household, localised, decorative	Instant lighting, direct connection, low cost, good colour rendering	Limited efficiency, dissipated heat, limited service life
Halogen incandescent	5 to 800	15 to 25	2000 to 4000	Intense or spot lighting	Instant lighting, direct connection, excellent colour rendering	Medium luminous efficiency, consumption
Fluorescent tube	4 to 60	50 to 100	10,000 to 25,000	Shops, workshops, offices, outdoor	Luminous efficiency, good colour rendering, long service life	Size, requires a ballast
Compact fluorescent bulb	5 to 40	50 to 80	10,000 to 20,000	As replacement for incandescent lamp	Same as fluorescent tube, smaller size	Does not light instantly
HP mercury vapour	40 to 1000	25 to 50	15,000 to 25,000	Workshops, halls, sheds, outdoor	Efficient, correct colour rendering	Lighting time, toxicity of mercury
HP sodium lamp	40 to 1000	40 to 140	15,000 to 25,000	Outdoor, safety lighting	Very high luminous efficiency	Lighting time
LP sodium lamp	30 to 180	100 to 200	15,000 to 20,000	Outdoor, roadways	Visibility in fog (monochrome yellow lighting)	Lighting time, poor colour rendering
Metal halogenide	30 to 2000	50 to 120	5000 to 20,000	Large areas, stadia, halls	Efficient, long service life, good colour rendering	Lighting time
LED	0.05 to 1 (x no. of LEDs)	10 to 30	40,000 to 100,000	Signalling, signs, spot lights	Low consumption, low temperature, not sensitive to vibration and switching	Limited number of colours, low unit brightness, DC power supply

In addition to the installation of high-performance luminaires, it is advisable to install intelligent control systems: programmers, detection of the presence of people, automatic variation according to the natural light, etc.





Standard EN 15193 was devised to establish conventions and methods for assessing the energy requirements of lighting in buildings. It gives calculated methods (detailed and fast) and a measured method. It thus enables the amount of energy used for the internal lighting of buildings to be assessed and a numeric performance indicator to be provided that can be used for certification. A great deal of the standard is devoted to assessing the daylight dependency factor ( $F_{D,n}$ ) according to the different regions of Europe and thus enabling appropriate regulation of artificial lighting. By superimposing on this the occupancy conditions of the areas (offices, educational establishments, workshops, shops, etc.) and target lighting values (per  $m^2$ ), it is possible to approximate the necessary power values, the regulation conditions and even lighting design criteria (distribution, colour rendering, glare, lighting layouts, etc.). Individual variation is also recommended as a method of making substantial savings (up to 40%).

### 1.3. Automation of solar protection

Solar gain through windows helps to reduce heating bills in cold periods, but considerably increases air conditioning requirements in hot periods. Automatic management of solar protection according to weather conditions, the height of the sun and whether or not areas are occupied therefore helps to optimise a building's consumption while providing optimum working conditions. Potential savings on cooling can range from 20 to 60%.



< Even before its automation, architectural design is the primary element for the management of solar gain



A motion detector installed at the entrance to an area that is used intermittently pays for itself very quickly as a result of the savings made. It controls luminaires automatically, switching them on and turning them off after a programmed time selected by the user. Lighting management in storage areas or offices does not have to involve huge lengths of wires and computerised central management: a few presence and/or lighting level sensors are all that is needed to save 50% on the lighting energy bill.



Automatic PLC transmitter-receiver switch with override



^ Controls for electrical blinds and awnings



# Economical use of energy (continued)



^ Controlled solar protection on an industrial building



Standard EN ISO 13790 (Performance of buildings/Calculation of energy requirements for space heating) is used for calculating the solar gain and the effects of protection (shading coefficient, optical properties).



Today, data centres are an example, or rather a counter-example, of the obvious need to manage energy consumption and are also proof that the idea of the availability of seemingly limitless energy is absurd. The power required to supply the data servers is almost totally dissipated in the form of heat (several Megawatts) that then has to be discharged by supplying cooling units which themselves consume large amounts of energy. The overall efficiency is very poor. Solutions are actively being sought to improve this rather odd situation, but they come up against the ever-growing need for computer applications, for which we all are partly responsible as users.

## 2 ELECTRICAL DISTRIBUTION PLANT

Although it is silent and almost forgotten once it has been installed, the power distribution infrastructure in buildings is nevertheless a potential source of savings. Of course, its component parts (HVA/LV transformer, busbars, MCCBs and distribution systems) do not consume energy in the usual sense, but the fact that high currents pass through them can lead to considerable losses, the effect of which is additional temperature rises that must be controlled and equivalent costs directly billed in kWh.

### 2.1. Energy consumption management

When energy consumption has to be managed, the control of the power devices in the electrical panels must be fast and reliable. The power supervision system offered by Legrand is designed to be able to monitor the status of the devices in real time and read all measurements locally or remotely.

### 2.2. Electrical infrastructure optimisation

This must form the subject of an in-depth study, which requires a good knowledge of the receivers that are to be installed.

Legrand can help with this process by providing you with technical publications such as this "Power Guide" and two complementary design software packages:

- XL PRO<sup>2</sup> Calcul, which can be used to determine cable cross-sections and protection devices, in full compliance with standard IEC 60364
- XL PRO<sup>2</sup> which, based on needs and requirements, can be used to create the electrical panels of an installation in full, right through to costing and preparation of the purchase order.



## Low loss transformers

Zucchini “Energy saving Transformers” enable substantial reductions in power consumption by reducing no-load losses. This advantage is particularly obvious when the transformer operates at low load, which is often most of the time. For example, a 1000 kVA low loss transformer will lead to an energy saving of more than 10,000 kWh a year on consumption. This saving may seem limited, but should be compared with an additional cost that will quickly pay for itself (in less than 2 years) and a saving that will continue year on year throughout the service life of the transformer. A calculation example is given on Book 2 “Power balance and choice of power supply solutions”.

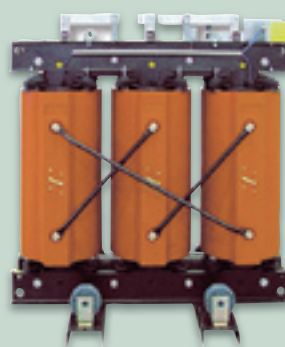

Zucchini transformer



## Detailing requirements by means of specifications

For requirements to be dealt with effectively, those concerning the environment and energy efficiency must be incorporated in the specifications (General Specifications and Special Technical Specifications). Although as a general rule the specifications include information on the impact of the location of the building project on its environment, the summer and winter thermal comfort objectives and all the obligations required to comply with thermal regulations, the elements and solutions designed to make savings by means of the infrastructure of the building or its electrical utilities are not always described in enough detail. This is true of lighting devices, whose performance is very variable, but even more so for the lighting management or energy-saving systems (dimming, detection, etc.). The same can be said of heating or ventilation management devices, which are often seen as optional from the point of view of their direct cost, without taking into consideration the potential savings they can provide during operation. Finally, the aspects of the electrical power architecture are often not described in detail as they are not directly used by the public, whereas they too can be a significant source of energy savings.



## Zucchini busbar trunking

From 25 A to 5000 A: one system adapts to all applications. Zucchini busbar trunking systems reduce losses in high power links and in particular in those between transformers and main distribution panels. The SC (650 to 5000 A) and HR (1000 to 5000 A) ranges are particularly designed for this function. In a multi-cable link it is difficult to balance the currents in the conductors, and the mutual inductance effects between them are a source of additional losses. Busbar trunking overcomes this problem of symmetry and compensates for the related losses by providing optimised energy transport systems, with very little temperature rise and minimum electromagnetic radiation. Furthermore, at such power levels, the mechanical safety these systems provide by their self-supporting structure is an additional advantage for even greater safety.

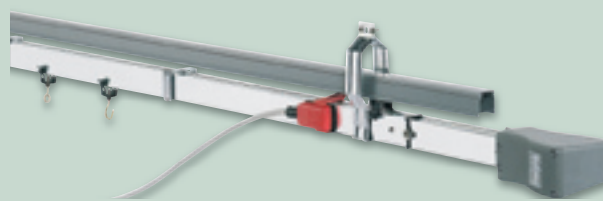

# Economical use of energy (continued)

## 2.3. Reactive energy compensation

Reactive energy, mainly generated in industry by the large numbers of electric motors used, by welding machines, arc or induction furnaces and power rectifiers, is generally billed by the energy supplier. As well as the obvious savings made on bills, limiting the consumption of reactive energy ( $\tan \varphi$  close to 0) also limits the energy losses in cables, and thus limits the voltage drops in those cables and improves the level of power available (in kVA) in the installation. Compensation systems can be installed at several levels within the installation, each of which has advantages and disadvantages (see Book 3 "Electrical energy supply").



**In the context of future installations, it is advisable to take compensation into account at the commissioning stage. In this case, it is not possible to calculate the capacitor bank using traditional methods (analysis of bills or on-site measurement).**

**It is therefore advisable to install a capacitor bank equal to approximately 25% of the nominal power of the corresponding HV/LV transformer.**

**Example: for a 1000 kVA transformer, the Q value of the capacitor will be 250 kvar**

**Note: this type of ratio corresponds to the following operating conditions:**

- 1000 kVA transformer
- Actual transformer load = 75%
- $\cos \varphi$  of the load = 0.80
- $\cos \varphi$  to be obtained = 0.95

**$Q_c = 1000 \times 75\% \times 0.80 \times 0.421 = 250 \text{ kvar.}$**

**Legrand has an extensive range of capacitors for all types of installation**



**Alpivar power capacitors**

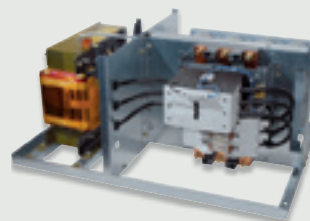

**Racks with detuned reactors**



**Standard automatic capacitor bank: Alpimatic range**



**Power factor controllers: Alptec range**



## Levels of installation

### ■ Global installation

#### Advantages:

- No reactive energy bill.
- Represents the most economical solution since all the power is concentrated at one point and the expansion coefficient makes it possible to optimise banks.
- Relieves the transformer.

#### Remark:

- The losses in the cables are not reduced.

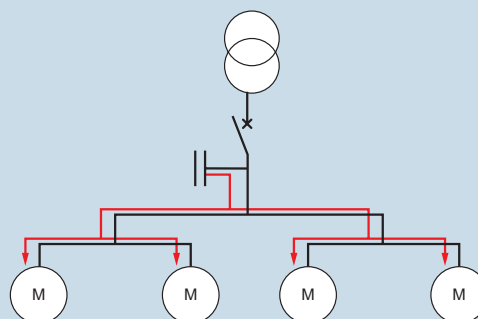

### ■ Sector installation

#### Advantages:

- No reactive energy bill.
- Relieves most of the line feeders and reduces Joule's heat losses in these feeders.
- Incorporates the expansion of each sector.
- Relieves the transformer.
- Remains economical.

#### Remark:

- Solution generally used for a very large plant network.

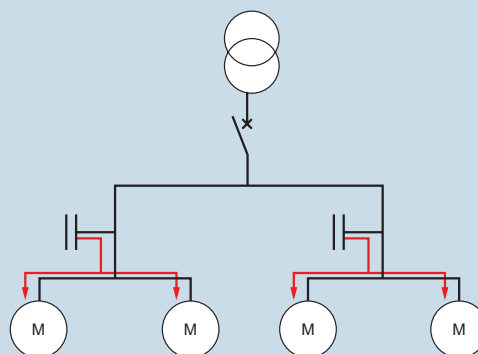

### ■ Individual installation

#### Advantages:

- No reactive energy bill.
- From a technical point of view, the ideal solution since the reactive energy is produced in the same place as where it is consumed; therefore, the Joule's heat losses are reduced in all the lines.
- Relieves the transformer.

#### Remark:

- Most costly solution given:
  - The high number of installations
  - The non-incorporation of the expansion coefficient.

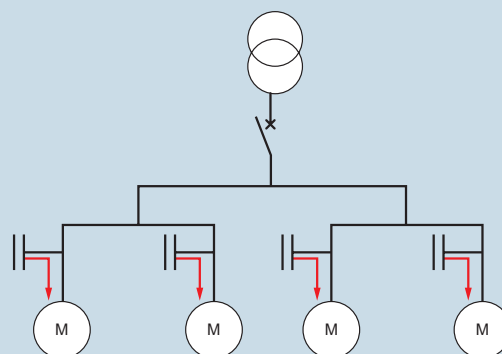

# Economical use of energy (continued)

## 2.4. Filtering harmonics

There are numerous non-linear loads in industry (asynchronous motors, rectifiers, speed drives, arc furnaces, switching mode power suppliers, etc.). They inject non-sinusoidal currents on the supply and are thus responsible for the appearance of harmonics (see Book 3 “Electrical Energy Supply”). The effects of this distortion of the current include abnormal temperature rises (heat losses), false tripping and deterioration of the power factor (see Book 2 “Power analysis and choice of power supply solutions”). It is possible to confine the harmonics by isolating devices that cause interference by transformer decoupling. Another more widely used solution is to install passive or active harmonic filters. The potential savings can reach 10 to 15% by reducing heat losses, and thus also increasing the available power and improving the efficiency of motors.



^ Power analysers and network analysers are used to ascertain the exact electrical consumption characteristics and thus adapt compensation and harmonic filtering devices

## 2.5. Measurement systems

In the context of a project to optimise energy resources, the measurement system (software and instrumentation) is used to collect relevant, customised information and thus simulate the economic effect of the actions to be implemented.



^ Legrand has a comprehensive range of equipment for taking these measurements, consisting of analysers, analog measuring devices (ammeters, voltmeters, etc.), digital measurement control units, hour counters, etc. Each of these devices can be used permanently or when required at the relevant location in the installation: supply end, distribution, dedicated circuit



## POWER GUIDE: A complete set of technical documentation



01 | Sustainable development and energy efficiency



08 | Protection against external disturbances



02 | Power balance and choice of power supply solutions



09 | Operating functions



03 | Electrical energy supply



10 | Enclosures and assembly certification



04 | Sizing conductors and selecting protection devices

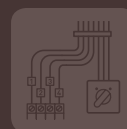

11 | Cabling components and control auxiliaries



05 | Breaking and protection devices

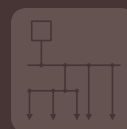

12 | Busbars and distribution



06 | Electrical hazards and protecting people



13 | Transport and distribution inside an installation



07 | Protection against lightning effects



Annexes  
Glossary  
Lexicon



**World Headquarters and  
International Department**  
87045 Limoges Cedex - France  
☎ : + 33 (0) 5 55 06 87 87  
Fax : + 33 (0) 5 55 06 74 55